

Home Comfort Group



BOSCH

Bosch Connected Control BCC110 Wi-Fi Thermostat

Installation Guide & User Manual

GET THE MOST
OUT OF YOUR NEW
THERMOSTAT

Download
The Bosch
EasyAir App

[Bosch-homecomfort.us](https://www.bosch-homecomfort.us)

Table of Contents

Installation Guide

- 4** Compatibility
- 6** Thermostat Installation
- 11** Initial Setup
- 20** Advanced Settings
- 23** Troubleshooting
- 25** Wiring Diagrams

BCC110 Device User Manual

- 31** Thermostat Main Screen
- 32** Icons
- 34** Temperature Setpoints

Thermostat Overview

- 35** Unit Operating Mode
- 35** Fan
- 36** Accessory
- 37** Additional Information

BCC App User Manual

- 39** Bosch EasyAir App
- 40** App Main Screen Overview
- 41** Setpoint(s) on the App
- 42** Schedule Overview

App Menu Overview

- 44** Mode
- 44** Device Messages
- 44** Temperature

Additional Features

- 46** Alexa
- 48** Google Assistant
- 50** Warranty & Legal

Meet the Bosch Connected Control (BCC110 Thermostat)

The Bosch Connected Control BCC110 Thermostat is compatible with the majority of 24V heating and cooling equipment to help you save energy and money. Easily control your home's temperature from the full color 5" touchscreen display, the Bosch EasyAir app or your voice with the Bosch Connected Control Alexa Smart Home Skill and your Alexa-enabled smart devices or with Google Assistant.



Connectivity

Connect to your HVAC equipment from anywhere



Weather

Access your local forecast from your thermostat



5" Full-Color Touch Screen

Large screen for ease-of-use and offline access



HVAC Filter Reminder

Get alerts when its time to replace your system's filter



Programmable

Follows preset or user-defined schedules



Compatibility

Compatible with majority of HVAC systems
(requires C-wire)



Enabled Smart Devices Compatible

Works with Google Assistant or Amazon Alexa



Compatibility

- ▶ A C-wire (common wire) is required to power the unit. Two wire systems are not supported. If a C-wire is not readily available, we recommend you seek professional support from your local contractor.
- ▶ The Bosch Connected Control BCC110 Wi-Fi Thermostat works with most 24V systems, including gas, oil, propane, electric, forced air, variable speed, heat pump and radiant.
- ▶ For conventional (gas/oil/electric): Heat Only, Cool Only, and Combined Heat & Cool. For heat-pump systems: Up To 4-Heat & 2-Cool. The BCC110 is not compatible with other Bosch Boiler controls, such as the Logamatic.

The thermostat cannot support

- ▶ Line voltage thermostats
- ▶ Electric baseboard heaters
- ▶ Proprietary communicating thermostats
- ▶ Millivolt systems
- ▶ Remote sensors

Professional installation is recommended for the following systems

- ▶ Dual Fuel systems (Heat Pump combined with a Furnace)
- ▶ Whole-home humidifiers and dehumidifiers



Are you unsure of your system compatibility or how to install your thermostat and need help?

- ▶ Self-support videos can be found on our website
- ▶ Contact our support team at 1-800-283-3787

Installation Overview

Included in the box

- ▶ BCC110 Wi-Fi Thermostat
- ▶ Screws (2) and Anchors (2)
- ▶ Flathead Screwdriver
- ▶ Wire Labels
- ▶ Jumper Wire
- ▶ User Guide
- ▶ Customer Support Card

Tools you will need

- ▶ Medium Phillips screwdriver
(for attaching the Wall Plate to the wall)
- ▶ Smartphone
(for taking pictures of the existing wiring)
- ▶ Bosch EasyAir app
(For registering your device)



Tools you may need

- ▶ Needle-Nose Pliers (for pulling wires from the wall)
- ▶ Drill with 7/32" Drill Bit (for mounting wall anchors)
- ▶ Wire Stripper (for cutting and stripping wires)
- ▶ Multimeter (for testing circuit power and continuity)
- ▶ Pen or Pencil (for preventing wires from falling into the wall)

Once you have everything you need, let's get started!

Thermostat Installation

Step 1

Turn OFF power

Turn off all power to your HVAC (Heating, Ventilation, and Air Conditioning) system by using the master equipment switch or circuit breaker box.

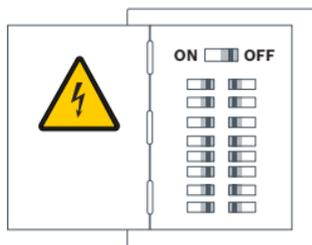

WARNING: Failure to turn off the power may result in electrical shock and/or damage to the equipment.

Confirm that your system is off

One way to do this is to try to adjust the temperature on your old thermostat. If you don't hear the system turn on within 5 minutes, air does not come out from the vents or the old thermostat does not even power on, then you have successfully turned off the power to your system.

Step 2

Remove the old thermostat from the old wall plate

OLD WALL PLATE

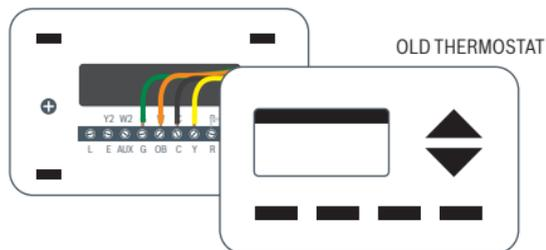

Step 3

Make sure your old thermostat

Does Not Contain Line Voltage Wiring

If you see any of these wire nuts, unfortunately the BCC110 may not work with your system. If you are unsure or would like to discuss your options, please contact a professional or our support line: 1-800-283-3787.



Step 4

Take a picture of the existing wiring

Make sure that you can clearly read the terminal labels and see which wires are connected to which terminals from your photo. You will need to reference this photo later during the initial setup.

Note: You can also use the wire labels we have provided you to correctly label each wire based on the terminal where it is connected.



Step 5

Confirm you have a C-wire connected to your old thermostat wall plate

If you do not have a C-wire connected to your old thermostat, please contact a professional or our support line for further assistance to determine if the BCC110 Thermostat is compatible with your system.

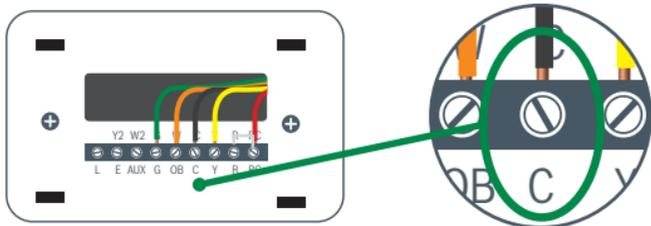

Step 6

Disconnect the wires from the old thermostat and remove the wall plate using a screwdriver

Some thermostats will also require you to use a screwdriver to disconnect the wires. After the wires are disconnected and the wall plate removed, we recommend wrapping a pen or pencil around the wires to prevent them from falling back into the wall.

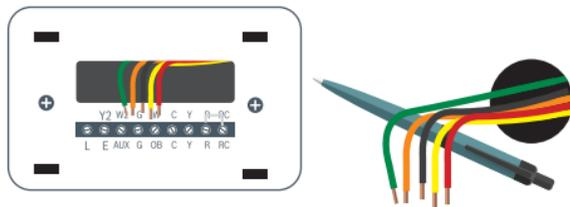

Step 7

Pull thermostat wires through the hole in the center of the BCC110 wall plate and mark the location of the mounting screws

It is recommended to use the BCC110 Wall Plate as a reference guide to mark the mounting holes and ensure that all holes and unpainted surfaces are covered.



Thermostat Installation

Step 8

Drill and insert wall anchors (if necessary)

Drill two 7/32" holes where you marked the location of the mounting screws and then insert the wall anchors provided into these mounting holes.

Check if the wall plate is level and insert screws

Make sure your new BCC110 wall plate is level and insert the included screws from the package. Mount your new wall plate to the wall using a Phillips head screw driver.

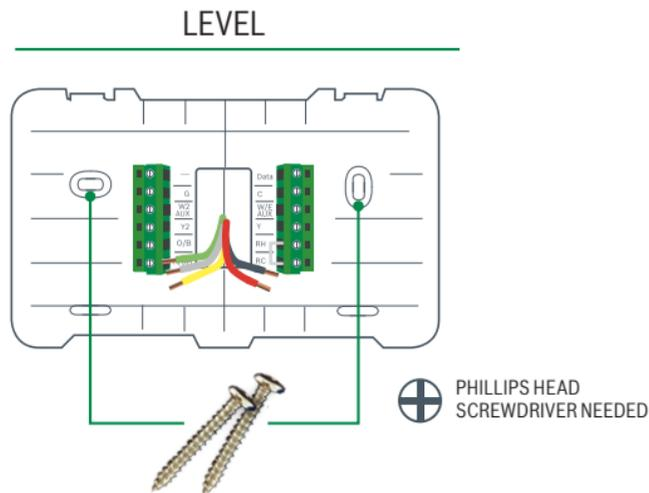

Step 9

Insert each wire into the corresponding terminal and close each terminal using a flat head screw driver

Use the image you took with your smartphone of your old thermostat wiring or the wire labels as a reference for where to place each wire. Be sure that you insert each wire, one by one, and then immediately close the terminal and confirm that the wire is secure inside the terminal before moving to the next wire. Repeat this process for each wire to be installed. If you are unsure of the terminal names on the BCC110 Wall Plate, refer to BCC110 Terminal Key on the next page.

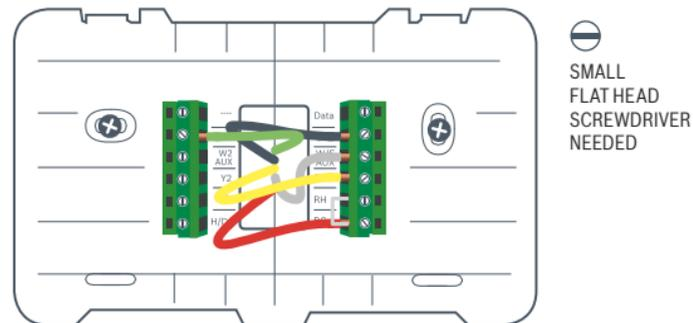

BCC110 Terminal

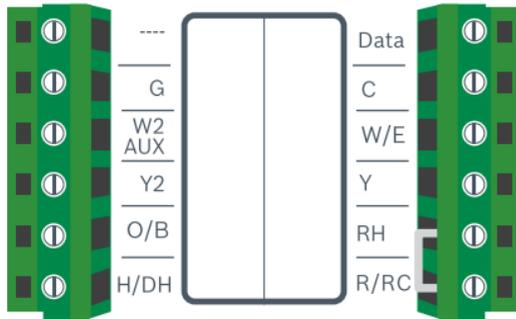

BCC110 Terminal Key

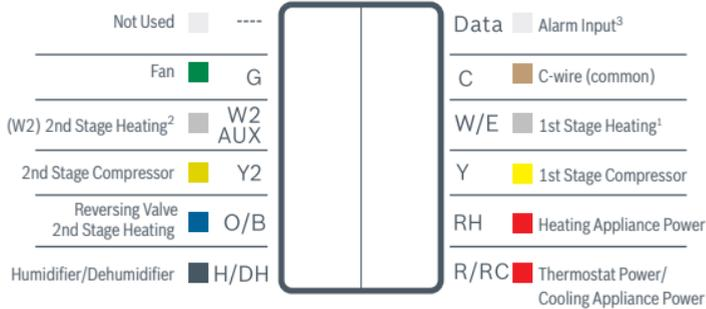

Note: The color of your wires may not be the same as shown
 (1) Emergency Heat activated at W/E,
 (2) Single-stage Auxiliary heat activated at W2/AUX,
 (3) Only to be used with Bosch WSHP

Step 10

After all wires are securely connected, gently push any excess wires back into the hole in the wall



Step 11

Attach the BCC110 thermostat to the BCC110 wall plate

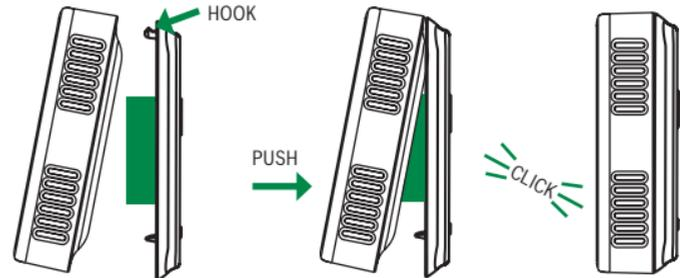

Thermostat Installation

Step 12

Turn ON the power to your HVAC by using the master equipment switch or circuit breaker box

The thermostat will power on and display a Bosch logo and loading bar.

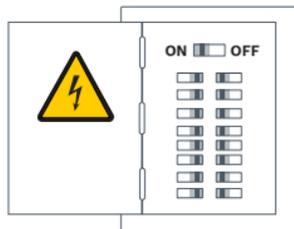

Note: After loading completes, the thermostat will display the following screen:

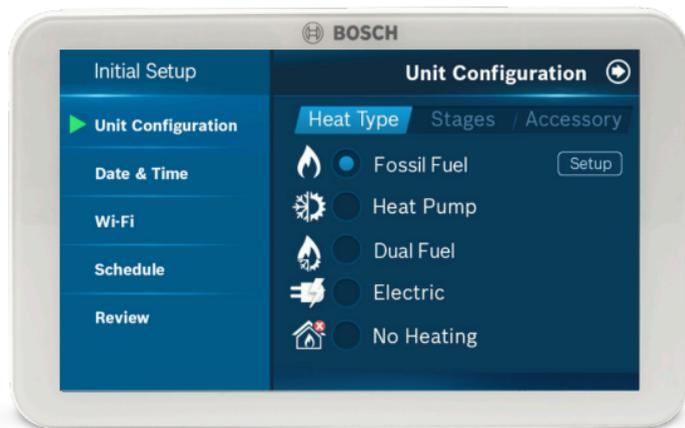

Step 13

Great job, the hard part's over!

Next, get your smartphone and visit your app store. Download the Bosch EasyAir app to setup your new BCC110

Your BCC110 Thermostat is not yet configured to your home's HVAC system. Go to the Apple App Store or Google Play Store to download the app, create an account, and finish configuring your system.

Three ways to download the Bosch EasyAir App:

- ▶ In the Apple App Store or Google Play, search "Bosch Connected Control" or "BCC110" and then download the app.
- ▶ Visit [Bosch-homecomfort.us/BCC110](https://www.bosch-homecomfort.us/BCC110)
- ▶ Scan QR code below. Click the links for the app in the Download App section.



Initial Setup

User Account Setup

1. After downloading the Bosch EasyAir App, open the app on your smartphone and accept the terms and conditions
2. Enter an e-mail address and password with which you would like to register.
3. To begin creating your profile, select your role as “Homeowner”.
4. Input your first and last name.
5. Verify phone number by entering the phone verification code you receive via text.
6. Your profile has been successfully created.

Add Device

1. After successfully creating your profile, choose the Appliance you would like to add, in this case BCC110.
2. Return to your thermostat and click Ok to initiate the Initial Setup.
3. Follow the on-screen instructions to name your thermostat and connect your smartphone to the device.
4. Follow the on-screen instructions to name your thermostat and connect your smartphone to the device.

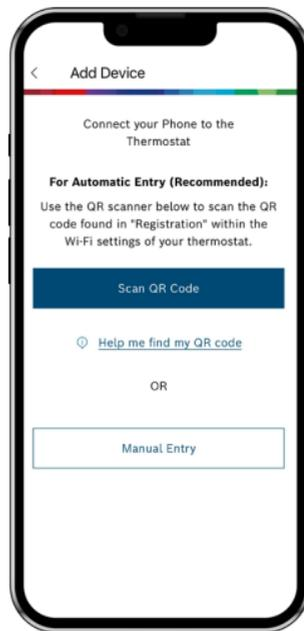

MAC ID and Temporary Verification Code

You can find the MAC ID and Temporary Verification Code by navigating to the Wi-Fi Settings screen on your thermostat and clicking the Registration button.

Initial Setup

For a quick and easy way to begin using your new smart thermostat, the device will automatically direct you to the Initial Setup screen after you have turned it on for the first time.

Unit Configuration

Select your home's heating type, stage configuration for heating and cooling, and type of accessory (humidifier or dehumidifier) if available.

Select your heat type

Select your Heat Type according to the heating appliance located in your home. Below is a list of helpful tips that may guide you to selecting the correct option for your home.

Note: If you are unsure of which option to select, contact your local contractor or our support line: 1-800-283-3787.

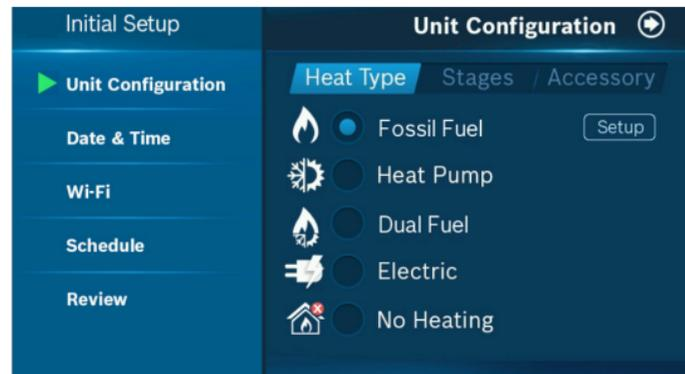

If you have a furnace

1. Select Fossil Fuel and click the Next Arrow at the top right corner of the screen.
2. Then select Appliance or Thermostat depending on your personal preferences for fan control.
3. Click Next Arrow at the top right corner of the screen.

If you have a boiler

1. Select Fossil Fuel and click the Next Arrow at the top right corner of the screen.
2. Then select Appliance
3. Click Next Arrow at the top right corner of the screen.

If you have a heat pump

1. Select Heat Pump and click the Next Arrow at the top right corner of the screen.
2. Then follow the on-screen instructions.
3. Click Next Arrow at the top right corner of the screen.
4. Configure the reversing valve for O (energized in cool) or B (energized in heat) and enable/disable Emergency Heat and/or Auxiliary Heat.

If you have a dual fuel system

1. Select Dual Fuel and click the Next Arrow at the top right corner of the screen.
2. Then follow the on-screen instructions to configure the fossil fuel fan control settings
3. Click Next Arrow at the top right corner of the screen. Then follow the on-screen instructions to configure the heat pump dual fuel changeover settings.

4. Use the Balance Point to set the outdoor temperature value the thermostat will use to switch between your heat pump and fossil fuel appliance. Above this value, your thermostat will use your heat pump to heat your home and below this value, your thermostat will use your fossil fuel heating appliance.
5. Use the Change over Delay to set the time the system will be off when changing between heat pump and fossil fuel heating sources. This delay allows for the coil to cool before switching between heating appliances.

Note: In a dual fuel system, the BCC110 automatically enables auxiliary heating using the fossil fuel heating appliance.

Note: In a dual fuel system, the BCC110 will stage up from heat pump to fossil fuel following the stage settings, which can be modified in Advanced Settings > Installer Access > by using the ST Action Code.

6. Click Next Arrow at the top right corner of the screen.

If you have an electric system

Select Electric and click Next Arrow at the top right corner of the screen

If you have no heating appliance

Select No Heating and click Next Arrow at the top right corner of the screen

Select your stage configuration

Select your stage configuration according to the heating and cooling appliances you have in your home and then click Next Arrow at the top right corner of the screen.

Need Help?

If you are unsure of which option to select, contact your local contractor or our support line: 1-800-283-3787.

If you have a whole home humidifier or dehumidifier accessory wired to your thermostat, select the type of accessory you have in your home; otherwise, click None and then click Next Arrow.

Note: Professional installation is recommended for humidifiers and dehumidifiers.

If you have a Humidifier

1. Select Humidifier and click the Next Arrow at the top right corner of the screen.
2. Then select Evaporative or Steam following the on-screen instructions. For Evaporative the humidifier is activated only during active heating. For Steam the humidifier is activated regardless of a heating call.
3. Click Next Arrow at the top right corner of the screen.

If you have a Dehumidifier

1. Select Dehumidifier and click the Next Arrow at the top right corner of the screen.
2. Then enable or disable Cool to Dehumidify following the on-screen instructions. If Cool to Dehumidify is enabled the dehumidifier is activated only during active cooling. If disabled the dehumidifier is activated regardless of a cooling call.
3. Click Next Arrow at the top right corner of the screen.

Initial Setup

Date & Time

Follow the on-screen instructions to set the date and time of BCC110 Thermostat and then click Next Arrow at the top right corner of the screen.

On Device

Enter your location's current date and time; after the device is registered or linked to a user account, the date and time on the device will automatically update to the current time associated with the user account.

APP

The date and time for the device, as well as the user account, will automatically update by selecting the time zone for the device.

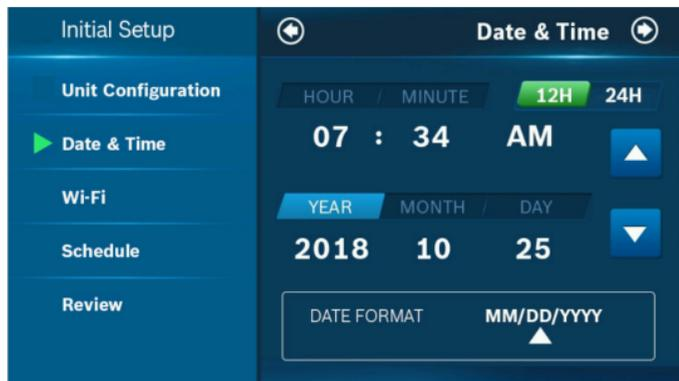

Wi-Fi

The BCC110 requires a reliable Wi-Fi connection in order to access smart features such as remote access, weather forecast and more. To complete the Wi-Fi setup, follow the on-screen instructions.

Scan

To start Wi-Fi setup, click the Scan icon to view available Wi-Fi networks. Follow the on-screen instructions to complete the Wi-Fi setup.

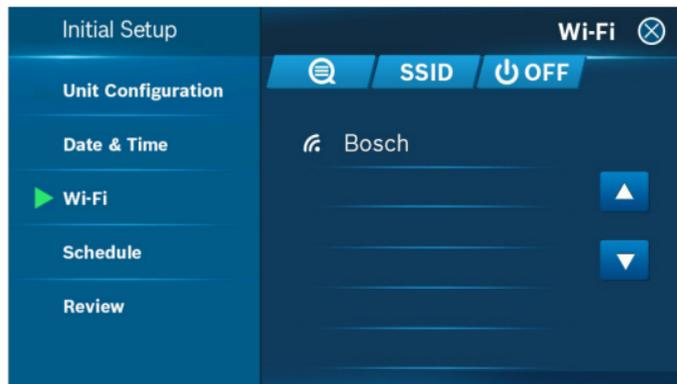

Manual Entry

If you are trying to connect to a hidden network, press the SSID button to bring up the SSID screen. Enter your SSID into the text box, then follow the on-screen instruction to complete the Wi-Fi setup.



Note: If this is a first time installation, follow the instructions in the App Setup section of this User Guide to register your thermostat to your smart device.

The following may cause a failed connection to the device:

- ▶ Wi-Fi signal is too weak
- ▶ 5 GHz Wi-Fi network is not supported
- ▶ SSID contains space or non-ASCII characters
- ▶ Incorrect password
- ▶ Wi-Fi is okay but your internet is unavailable
- ▶ Additional web authentication is not supported

After you have successfully established a connection, your network name appears. If your thermostat is already registered to your account on your smart device, your User ID name appears. Follow additional instructions on the screen to complete setup. After completing the setup, download the Bosch EasyAir App from the Apple Store or Google Play Store. Create an account within the app and then add a device (BCC110) by following the on-screen instructions.



Note: For all smart devices that require access to the same thermostat, you must use the same account.

Initial Setup

For an unregistered device, click the green Registration button to register your account. If you want to register a different account to your device, you can also click the Registration button and follow the steps outlined in the App Setup section of this User Guide.

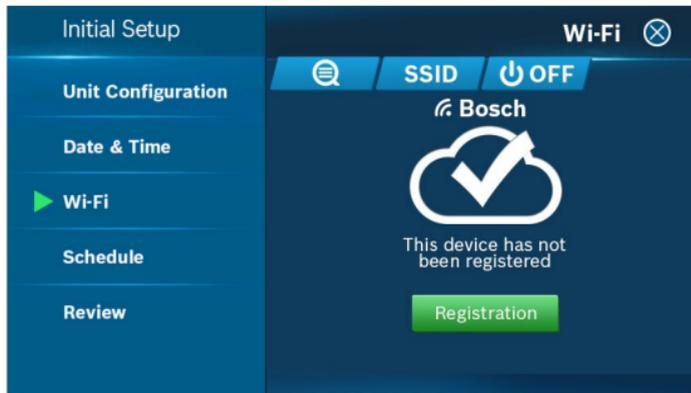

Auto Reconnect

If your device loses connection with your wireless network, it will automatically attempt to reconnect after 5 minutes. If that fails, it will make a new attempt every 15 minutes for the next 24 hours. Any manual network reconfiguration of the thermostat will stop automatic reconnection attempts.

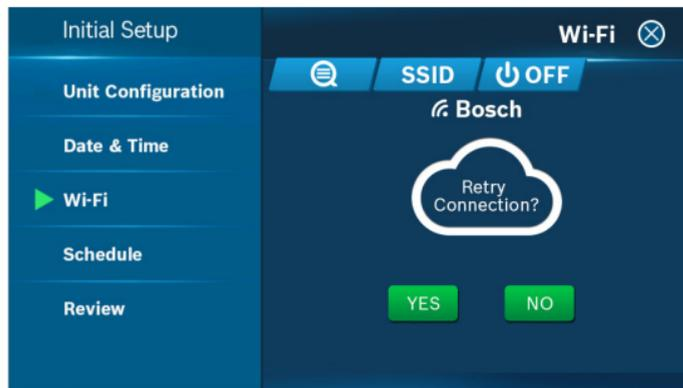

Schedule

Choose the schedule you would like to modify, or select No Schedule if you do not wish to set up a schedule at this time, and click the Setup button or Next arrow.

Note: Home is the default schedule for your BCC110. If you wish to add a different schedule, use the Bosch EasyAir App.

To set up your periods for the day, click on the Start Time bubble of the period and use the Up/Down arrows to set the start time of the first period of the day.

1. Next, click the Heat bubble and use the Up/Down arrows to set the heating setpoint for the first period of the day.
2. Then, click the Cool bubble and use the Up/Down arrows to set the cooling setpoint for the first period of the day.

Note: There is a 5 degree deadband required between heating and cooling setpoints to prevent equipment from short cycling.

3. If you want to add more periods, then click add period button and repeat the above 3 steps until you have set all your periods for the day.

Note: You are allowed a maximum of 8 periods per day.

4. If you want to delete a period, select any bubble corresponding to that period and click Delete.
5. After you have set up one day of the week, use the Copy section to mirror the same daily schedule to other days of the week by clicking on the days you would like to copy that daily set of periods. Then click next.

Note: If you have not copied your schedule to all 7 days of the week, you will be required to repeat the above steps until you have set a schedule for everyday of the week.

On Device

During offline operations, only 2 schedules (Home and Vacation) are available. However, when a Wi-Fi connection is established, the list can be expanded up to 4 schedules.

Home

You can use this schedule to set your heating/cooling equipment to predefined set points. The device initially comes with a factory default schedule, which can be adjusted as necessary.

Vacation

This schedule will be used to set your heating/cooling equipment to 2 periods with set points (1 heating and 1 cooling) that can be manually adjusted. However, you will not be able to add additional or remove current periods. The schedule can be used for vacation or permanently setting a heating/cooling set point.

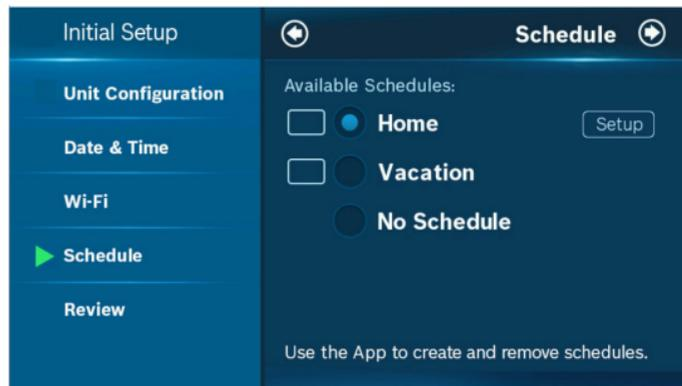

Initial Setup

Review

In the final step, the BCC110 provides a summary review of information that you have entered into the thermostat. You will be able to go back to different parts of the Initial Setup guide by pressing the different sections on the left pane or using the Previous arrow. If you have completed the review, please press the Complete button to start utilizing your BCC110!

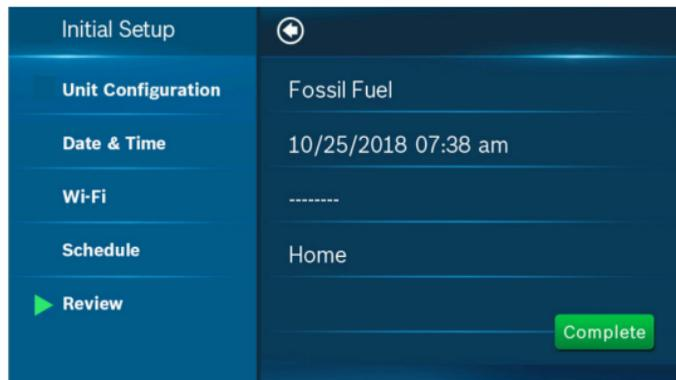

Congratulations!

You have finished the installation and setup of your BCC110 Thermostat. Thank you for choosing Bosch and enjoy the savings and comfort of owning your Bosch Connected Control thermostat!



Bosch Home Comfort Group

We invent sustainable heating, cooling and well-being solutions – for a smarter and better life.

Advanced Settings

Advanced Settings allow HVAC professionals the ability to modify specific thermostat settings for better control of the heating and cooling appliance(s). In order to access the Advanced Settings of the BCC110 Thermostat, your thermostat must be connected to Wi-Fi. The Advanced Settings section is accessible from the Menu of the BCC110 thermostat.

FOR CONTRACTORS ONLY: Advanced Settings are for professional use only and require an access code

ACCESS CODE: 1886

Installer Access

- ▶ To access the Installer Access, click Advanced Settings, enter the Professional Access Code and click Installer
- ▶ Enter any one of the Action Codes in parenthesis below to gain access to that specific setting:

Humidity Calibration (HC)

Ability to adjust humidity readings after extended product use.

Relative Humidity Hysteresis (HSD)

Adjust the set point differential for the humidity control.

Initial Setup (IS)

Initial Setup process.

Sensor Calibration (SC)

Ability to adjust temperature readings after extended use.

Sensitivity Level (SS)

The lower the level, the more your system cycles to maintain the set point(s).

Staging (ST)

Configuration options: Latching, Stage Delay and Stage Temp.

Advanced Settings

Heating & Cooling

- ▶ To access the Heating and Cooling, select Advanced Settings from the Menu, then select Heating and Cooling.
- ▶ Enter the Professional Access Code and select a parameter to modify the default value. From this menu you can adjust:

Title	Default	Max	Min	Description
Fan Delay On	0 Seconds	120 Seconds	0 Seconds	The fan's lag time after the heating or cooling call is initiated when in Fossil Fuel, Heat Pump, or Cooling operation.
Fan Delay On Elec	0 Seconds	5 Seconds	0 Seconds	The fan's lag time after the heating or cooling call is initiated when in Electric, Auxiliary heat, or Emergency heat operation.
Fan Delay Off	60 Seconds	120 Seconds	30 Seconds	The fan's lag time after the heating or cooling call is terminated.
Min. Run Time	5 Minutes	Stage Delay	3 Minutes	The minimum amount of time a heating or cooling call will run after the initial call. This timer resets and must be met after each stage up condition.
Anti Short Cycle	5 Minutes	5 Minutes	0 Minutes	The minimum amount of time a heating or cooling call will run after a stage down condition. This timer resets and must be met after each stage down condition.
Cycle Time	180 Seconds	300 Seconds	60 Seconds	Time delay required between system mode changes before active heating or cooling calls can begin.
Zero Energy Band Heating	1°F/0.5°C	2°F/1°C	0.5°F/0.3°C	A temperature range between the current temperature and the heating set point, where heating is not engaged.
Zero Energy Band Cooling	1°F/0.5°C	2°F/1°C	0.5°F/0.3°C	A temperature range between the current temperature and the cooling set point, where cooling is not engaged.
Deadband	5°F/3°C	9°F/5°C	2°F/1°C	A temperature range between the heating set point and cooling set point in Auto Mode, where heating/cooling is not engaged.

Troubleshooting & Frequently Asked Questions

Wi-Fi

Can the BCC110 be used without Wi-Fi?

We strongly encourage everyone to use the Wi-Fi capabilities of the thermostat, as it will improve the user experience. However, it is functional without the use of Wi-Fi after the Initial Setup has been completed.

NOTE: The Dual Fuel feature is disabled when Wi-Fi is unavailable. Dual fuel requires Wi-Fi to determine outdoor air temperature and function properly.

Will the BCC110 support all Wi-Fi systems & routers?

This device only works with 2.4 GHz systems and is NOT compatible with 5.0 GHz systems or web pages that require additional web authentication.

Trouble Connecting to your Home's Wi-Fi Network?

1. Make sure that your thermostat is a maximum 20 ft or less from the router/modem without any obstructions (i.e. walls, floors, ceilings, etc.). If obstructions exist, try moving your thermostat and router/modem closer together.
2. Before attempting to reconnect your thermostat to your home network, power cycle your router/modem and then your thermostat. If you have a separate router and modem, make sure that you power cycle the modem first and then the router.
3. In the event that you still cannot connect to your home's wi-fi network please contact our support team for further in-depth technical troubleshooting options.

NOTE: If you are able to connect to your home network, but the time does not update on the thermostat, you are not fully connected to the cloud server. Please follow the troubleshooting steps again or contact Bosch Technical Support.

Troubleshooting & Frequently Asked Questions

Bosch EasyAir App (Android and iOS)

What is the name of the smartphone app in the App Store and Google Play Store?

The name of the app is Bosch EasyAir App.

How many accounts can be associated with the thermostat at once?

Only one account can be associated with a given thermostat. Family members must share their account information with each other if they would like to be able to control the thermostat from multiple devices.

Can this device be accessed via a web page?

Not at this time.

Thermostat

What happens if I lose power to the device; will all my settings be lost?

All settings are kept in local memory, except for the schedule setpoints, which are stored in the cloud. Therefore, all settings will be saved even during a power outage.

Not Finding the Answer to Your Question?

- ▶ Self-support videos can be found on our website at: [Bosch-thermotechnology.us/BCC110](https://www.bosch-thermotechnology.us/BCC110)
- ▶ Contact our support team at 1-800-283-3787

Wiring Diagrams

BCC110 Terminal

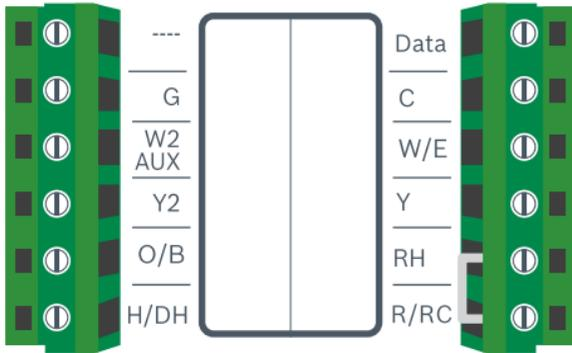

BCC110 Terminal Key

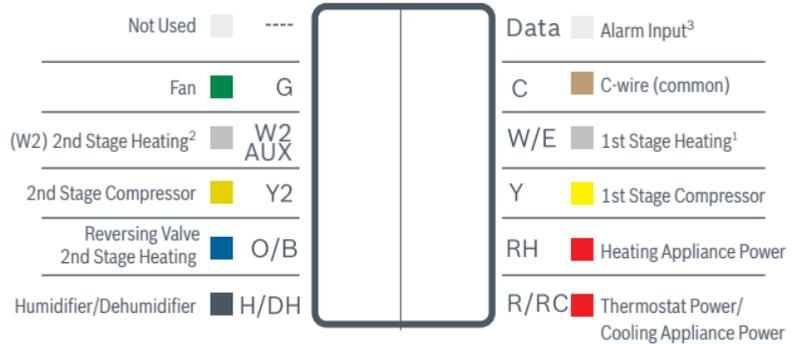

Wiring Diagrams

Single Stage Heat – Furnace

Example: Bosch 80% AFUE Gas Furnace - BGS80

- ▶ Ensure the system has a C-wire
- ▶ Ensure the pre-installed jumper wire remains between RH and RC
- ▶ Connect the R, C, W1 and G wires from the Furnace to R/RC, C, W/E and G terminals on the wall plate, respectively

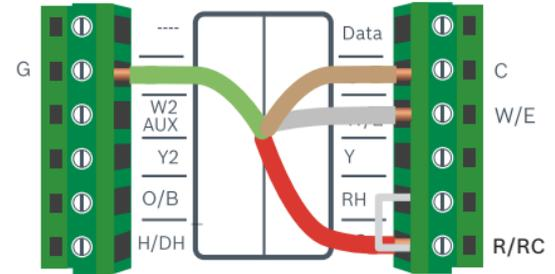

Two Stage Heat – Furnace

Example: Bosch 96% AFUE Gas Furnace - BGH96

- ▶ Ensure the system has a C-wire
- ▶ Ensure the pre-installed jumper wire remains between RH and R/RC
- ▶ Connect the R, C, W1, W2 and G wires from the Furnace to R/RC, C, W/E, W2/AUX and G terminals on the wall plate, respectively

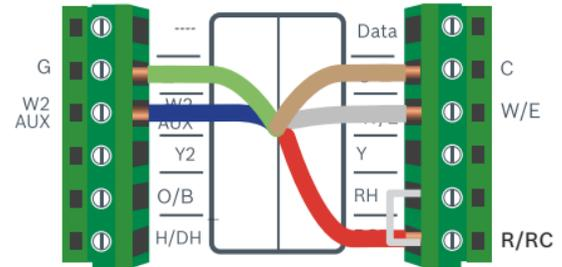

Wiring Diagrams

Single Stage Heat – Boiler

Example: Bosch Greenstar Gas Condensing Boilers*

- ▶ Ensure the system has a C-wire
- ▶ Ensure the pre-installed jumper wire remains between RH and RC
- ▶ Remove the jumper from the thermostat connection on the boiler and connect the two terminals to RH and W/E on the thermostat.
- ▶ ***NOTE:** Bosch Greenstar boilers will require an external transformer to power the thermostat. The two power wire should connect to R/RC and C on the Thermostat.

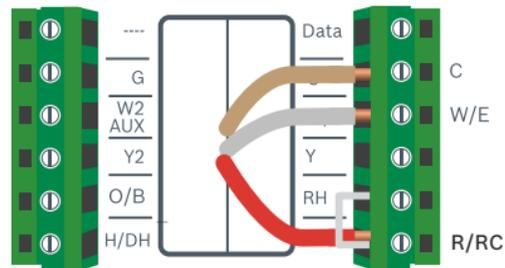

Combined Single Stage Heat Furnace and Single Stage Cool Air Conditioner

- ▶ Ensure the system has a C-wire
- ▶ Remove the pre-installed jumper wire from between RH and R/RC
- ▶ Connect the R, C, W1 and G wires from the Furnace to RH, C, W/E and G terminals on the wall plate, respectively
- ▶ Connect the R, C, Y1 and G wires from the Air Conditioner to R/RC, C, Y and G terminals on the wall plate, respectively

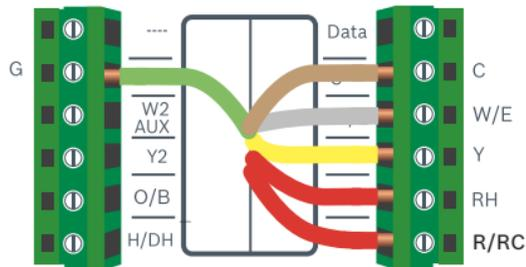

Wiring Diagrams

Heat pump systems

Heat pump systems are specialty designed to be able to provide heating and cooling using a single compressor, a reversing valve, and a fan.

Single Stage Heat Pump

Example: Bosch Inverter Ducted Split

- ▶ Ensure the system has a C-wire
- ▶ Ensure the pre-installed jumper wire remains between RH and R/RC
- ▶ Connect the R, C, Y1, O/B and G wires from the heat pump to R/RC, C, Y, O/B and G terminals on the wall plate, respectively

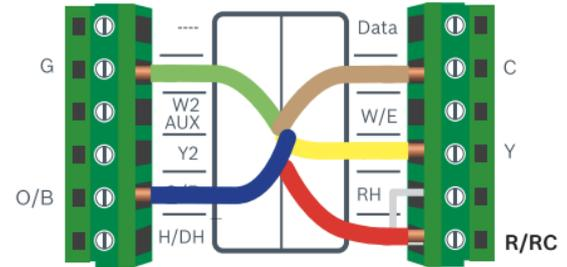

Single Stage Heat Pump with Emergency Heat and Auxiliary Heat

Note: W/E controls Emergency Heat output, and W2/AUX controls Auxiliary Heat output.

- ▶ Ensure the system has a C-wire
- ▶ Ensure the pre-installed jumper wire remains between RH and R/RC
- ▶ Connect the R, C, W1, Y1, O/B and G wires from the heat pump to R/RC, C, W/E, Y, O/B and G terminals on the wall plate, respectively
- ▶ Connect jumper wire between W/E and W2/AUX.

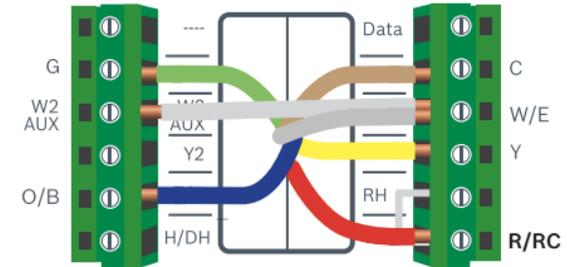

Wiring Diagrams

Two Stage Heat Pump with One Stage Emergency Heat

- ▶ Ensure the system has a C-wire
- ▶ Ensure the pre-installed jumper wire remains between RH and R/RC
- ▶ Connect the R, C, W1, Y1, Y2, O/B and G wires from the heat pump to R/RC, C, W/E, Y, Y2, O/B and G terminals on the wall plate, respectively

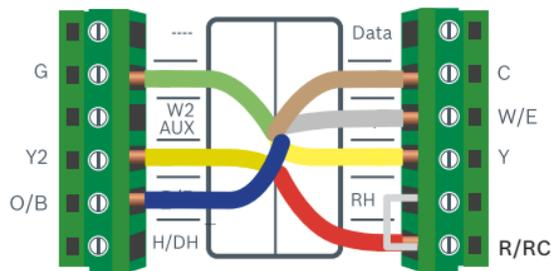

Single Stage Cool – Air Conditioner

- ▶ Ensure the system has a C-wire
- ▶ Ensure the pre-installed jumper wire remains between RH and R/RC
- ▶ Connect the R, C, Y1 and G wires from the Air Conditioner to R/RC, C, Y and G terminals on the wall plate, respectively

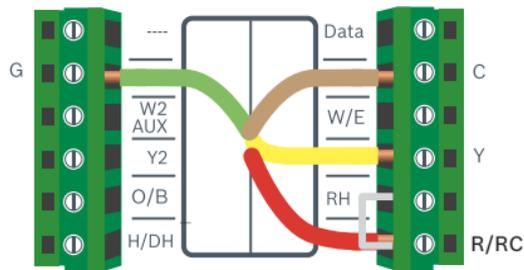

Wiring Diagrams

Combined Single Stage Heat Pump and Single Stage Furnace (Dual Fuel)

- ▶ Ensure the system has a C-wire
- ▶ Ensure the pre-installed jumper wire remains between RH and R/RC
- ▶ Connect the R, C, W1 and G wires from the Furnace to R/RC, C, W/E and G terminals on the wall plate, respectively
- ▶ Connect the C, Y1, G, and O/B wires from the Heat Pump to C, Y, G, and O/B terminals on the wall plate, respectively

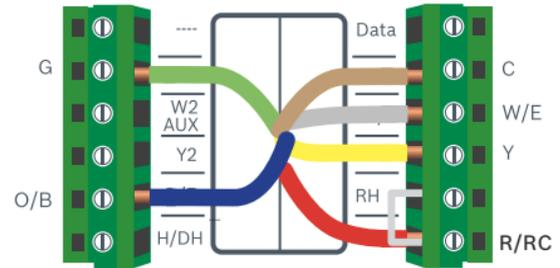

Humidifier or Dehumidifier Accessory with a Single Stage Heat Pump

A single Humidifier or Dehumidifier Accessory can be controlled using the BCC110. The thermostat only supports Humidifiers in heating operation, Dehumidifiers in cooling operation, and only one accessory per thermostat.

Note: The wiring configuration for humidifiers and dehumidifiers is the same for all type of Systems. The thermostat does not provide power to the accessory; only control.

- ▶ Ensure that the accessory is externally powered
- ▶ Ensure the Heat Pump System is wired correctly
- ▶ Connect the control wire of the accessory to the H/DH terminal of the wall plate

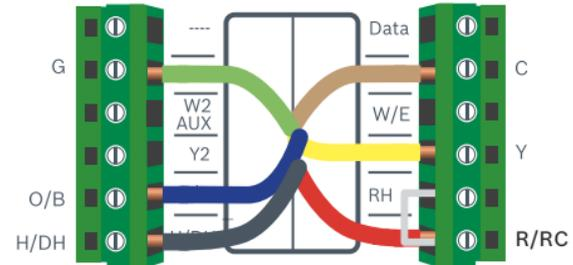



Main Screen



Thermostat and App Icons

Basic Icons

-  Menu
-  Exit / Save Settings
-  Back
-  Schedule
-  Device Settings
-  System Settings
-  Advanced Setting
-  Weather

System Modes

-  Heat Mode
-  Cool Mode
-  Auto Mode
-  Emergency Heat Mode
-  Off

Heating Types

-  Fossil Fuel
-  Heat Pump
-  Dual Fuel
-  Electric

Fan Modes

-  Auto
-  On
-  Circulation

Accessory

-  Humidifier
-  Dehumidifier

Unit Operation



Heat Mode
Heating on (1st stage) & (2nd stage)



Cool Mode
Cooling on (1st stage) & (2nd stage)



Auto Mode
Heating on (1st stage) & (2nd stage)



Auto Mode
Cooling on (1st stage) & (2nd stage)



Fan on/running (Fan Auto Mode)



Emergency Heating
Emergency heat on (1st stage) & (2nd stage)



Auxiliary Heating
Auxiliary heat on - 2nd Aux Stage of a 4-stage heating system

System Connectivity



Schedule on Device



Schedule on Cloud



Wi-Fi Connection Established



Wi-Fi Connection Not Established



Internet is Not Available



Retry Internet Connection

Adjusting Temperature Setpoint(s)

Temporary Adjustment

This feature will override the current set point in favor of the set point you enter until the next programmed time in the schedule. If you would like to permanently schedule the new set point, press the lock icon. This will permanently lock in the adjustment until the X button is pressed on the main screen.

Schedule Override on the Thermostat

You can override the current scheduled set point(s) by tapping the plus or minus (+/-) icons on the right side of the screen.

If you are in Auto mode, manually adjust either the Heat/Cool set points individually by selecting the appropriate bubble, then tapping the plus or minus (+/-) icons. If a Heat/Cool bubble is not selected pressing the (+/-) icons will adjust both setpoints simultaneously.

Schedule Override on the App

You can override the current schedule by scrolling the temperature up and down with your finger.



Thermostat Overview

Unit Operating Mode

Heat: The thermostat cycles your heating appliance to maintain your scheduled heating set point.

Cool: The thermostat cycles your cooling appliance to maintain your scheduled cooling set point.

Auto: The thermostat cycles your heating/cooling appliance to maintain your scheduled heating/cooling set points.

Off: The thermostat turns off all heating/cooling functions. You can still manually operate the fan in this mode.

Emergency Heat (available only with Heat Pumps): The thermostat turns off all compressor stage(s) and activates the back-up electric heat source(s).

Fan Operation

Auto: Fan will follow heating and cooling operations.

On: Fan runs non-stop.

Circulation: Fan cycles on and off regularly in addition to heating and cooling operations. By selecting this option, you also need to define the operation length of time and schedule for the circulation.

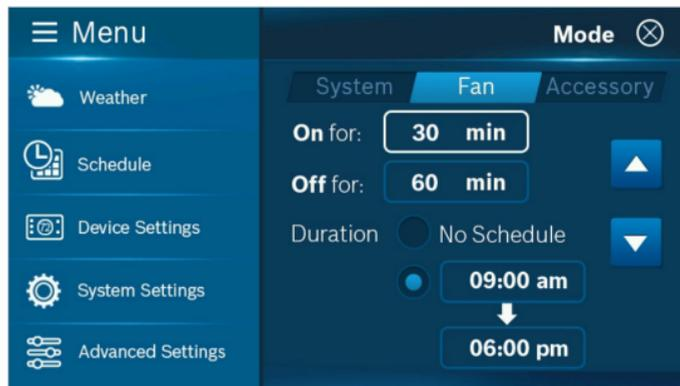
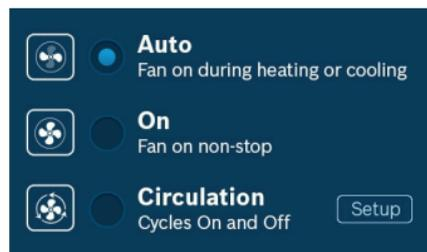

Thermostat Overview

Humidifier & Dehumidifier Operating Mode

You can enable automatic humidity control if the correct humidifier or dehumidifier accessory was correctly wired and configured during the thermostat's initial setup. Based on the setup, the thermostat turns on the humidifier during heating operation and the dehumidifier will be turned on during cooling operation. You can also configure the thermostat to operate similar to a humidistat, which runs the humidifier or dehumidifier, regardless of an active heating/cooling call.

Note: You may only operate in either humidifier OR dehumidifier mode and may not operate in both modes at the same time.



Temperature, Alerts, and Auto-On

Alert: Send an alert message or turn on the system automatically when the room temperature is out of the range between set-points.

Note: Alerts are an additional source of protection for your heating/cooling appliance.



Run Time

The thermostat keeps track of your run time for the Heating, Cooling, Air Filter and Water Pad. You can also set a reminder for Air Filter and Water Pad according to the number of calendar days. When it reaches its predefined run time, the thermostat displays a notification and sends a message to the registered smart device(s).

Additional Information

Weather Forecast

The weather forecast is based on the location of the installed thermostat. The first time you connect your thermostat to the app, your location was assigned to the thermostat.

Note: You must grant “location access” for the app to enable this feature.

Screen Options

There are 3 levels of screen brightness and 3 options for Screen Timeout.

You can also utilize this menu to Lock the screen. A 4-digit passcode will be required to lock the screen.

Note: It is important that you remember your screen lock passcode as you will not be able to unlock the screen without this code.

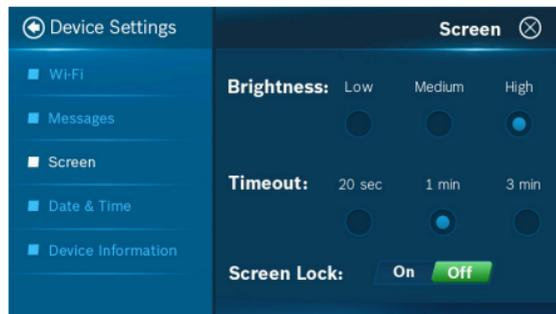

Device Information

Device information will contain all the relevant Account and System information.

Account: Change or remove the account associated with the thermostat.

System: Displays the current hardware and software information. This screen can also be used to update the firmware.

Factory Reset

To reset the thermostat to its default factory settings, select Advanced Settings from the main menu, and choose Factory Reset.

Note: All settings will be lost and you will need to repeat the Initial Setup process as outlined in the Installation Guide.

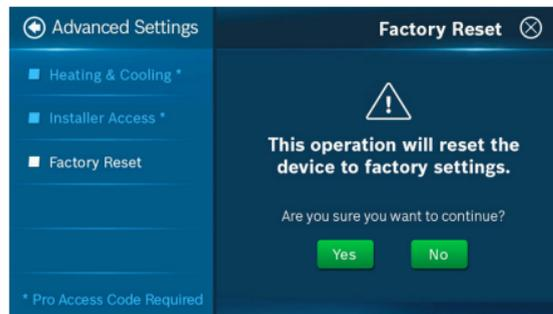

Download The Bosch EasyAir App

Control all of your thermostat's settings. Adjust your schedule on-the-go or set your home to vacation mode to save energy while you're away.



Bosch EasyAir App

The app allows you to remotely control all of your thermostat's settings. It also allows you to adjust your schedule on-the-go or set it to vacation mode to save energy while you're away. You can also connect an unlimited number of thermostats and manage up to 4 schedules per thermostat.

This is a perfect solution to help you achieve maximum comfort with minimum effort!

Three Ways to Download The Bosch EasyAir App

- ▶ In the App Store or Google Play, search "Bosch EasyAir App" and then download the app.



App Home Tab

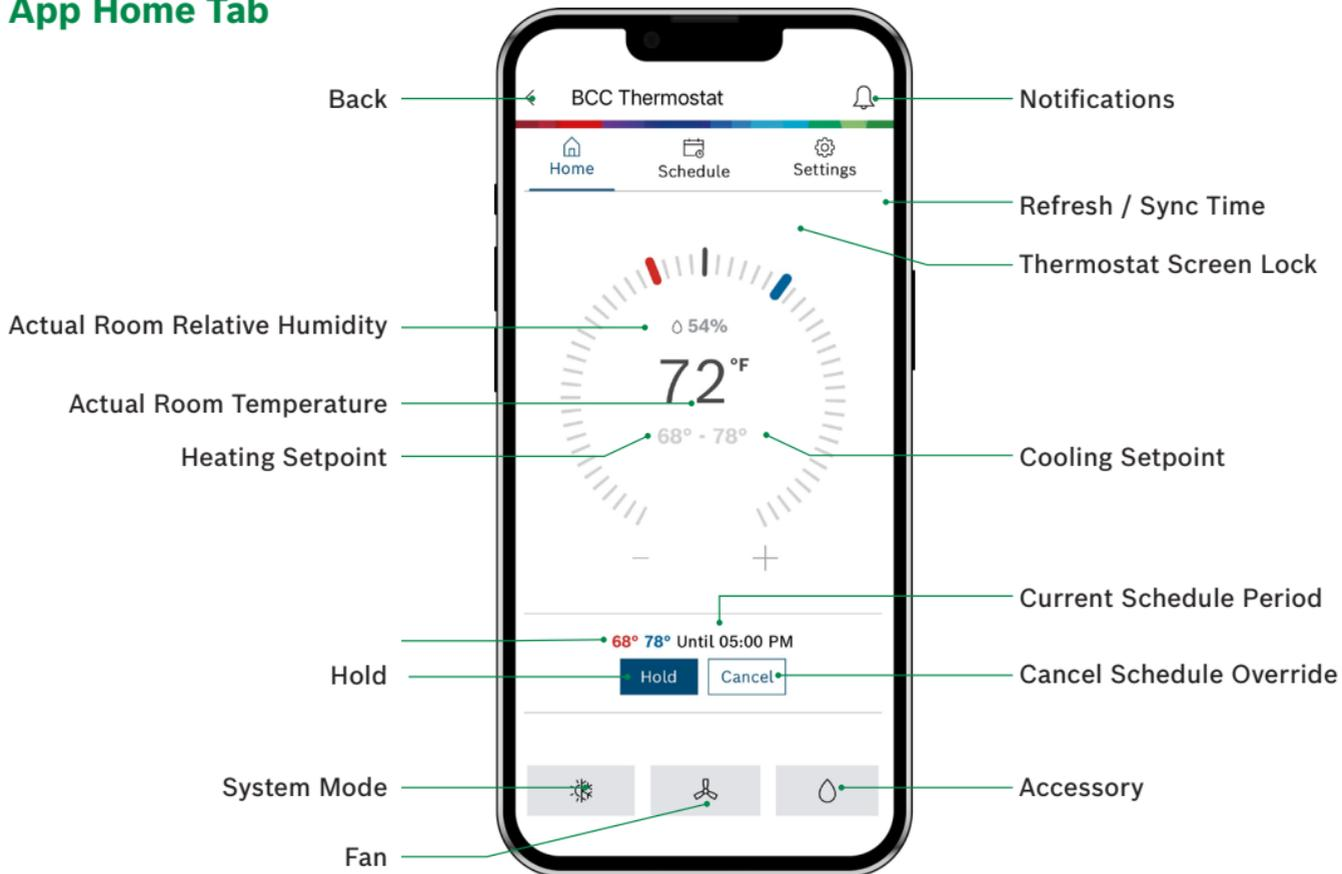

Adjusting Temperature Setpoint(s) on the App

No Schedule

tap the current temperature set point and use your finger to drag it left or right to change it. You can also use the “+” and “-” buttons to adjust the set point after tapping it. Stop on the value you want for your new setpoint and wait a few seconds for the setpoint to update. You will see the update reflected on the app and on the thermostat.

Note: When the thermostat is in Auto mode, you must first select either heat or cool, depending on which setpoint you would like to modify, and then follow the steps above to change the setpoint.



Schedule

Follow the same process as above to change the setpoint, but be aware that you are only changing the setpoint temporarily, until the next scheduled period listed on the app. If you would like to change the setpoints for the schedule periods, please see the section Schedule further on in this Manual.

Note: Click Hold to override the temperature setpoint permanently. You can cancel the temporary and permanent overrides at any time by clicking Cancel.

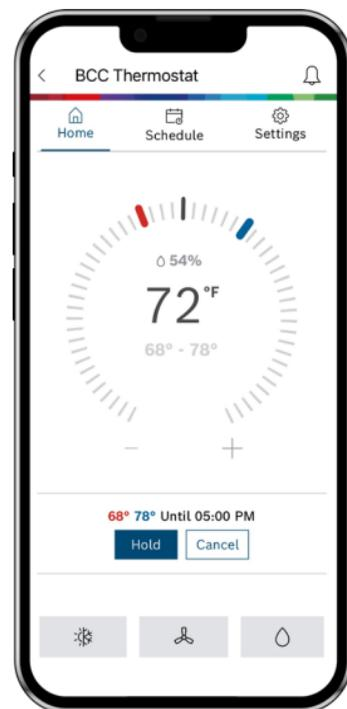

Schedule Overview

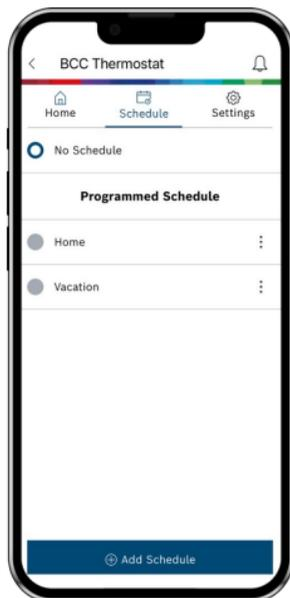

Schedule

- ▶ To add a new Schedule, use the "Add Schedule" button at the bottom, name your schedule and click OK.
- ▶ To modify an existing Schedule, click on the 3 dotted menu button on the schedule you want to modify and select "Edit" or "Delete".

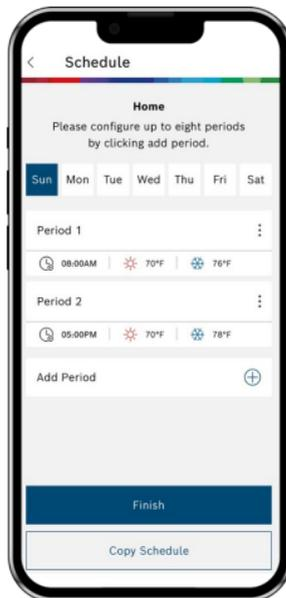

Add a New Period

To add a new Period to a given day, click the Add Period button in the middle of the screen. Then individually select and set the Starting time, Heat setpoint and Cool setpoint.

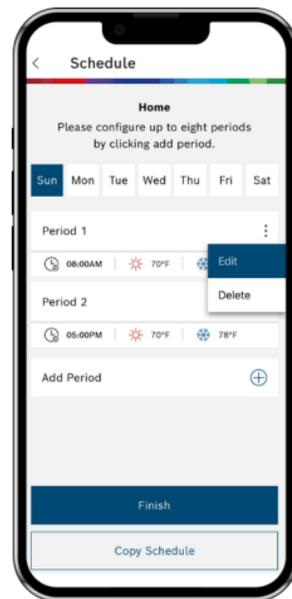

Edit an Existing Period

To modify an existing Period, click on the 3 dotted menu button on the period you want to modify and select "Edit", Then click on the Starting time, Heat setpoint or Cool setpoint value you would like to edit and use the scroll wheel to update the value.

Schedule Overview

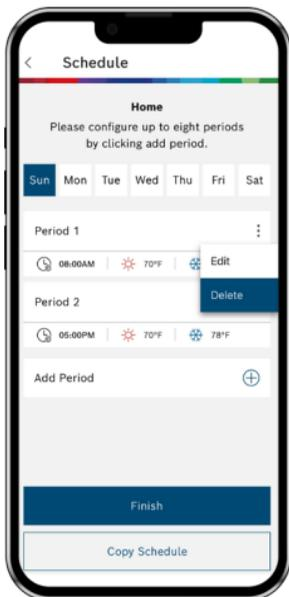

Delete an Existing Period

To delete an existing period, click on the 3 dotted menu button on the schedule you want to delete and select “Delete”.

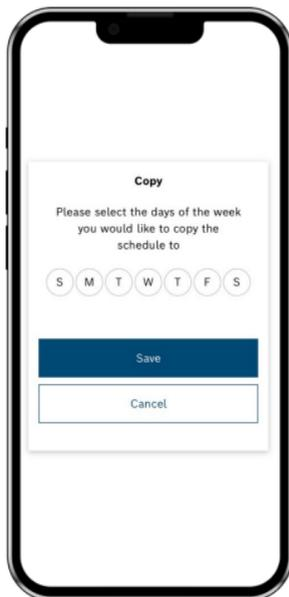

Copy a Schedule

To copy a schedule to other days of the week, click on the “Copy Schedule” button. Then lettered days at the bottom of the screen until all days you would like to copy in the existing schedule have turned green and click Copy Schedule.

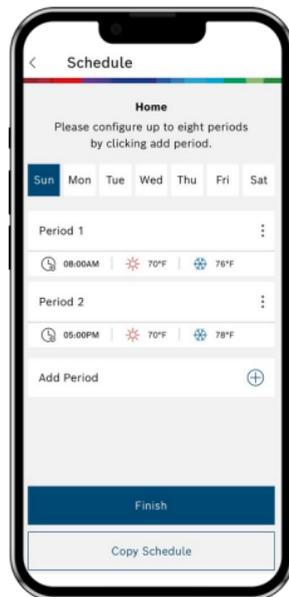

Save Schedule

Use the Finish button to save all changes.

App Dashboard Overview



Home

View room temperature and adjust set point. Use the buttons at the bottom of the BCC Home tab screen to remotely adjust the System Mode, Fan Mode and Accessory Mode.

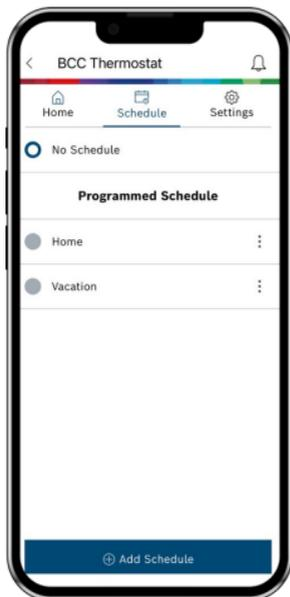

Schedule

Select schedule or follow on screen instructions to edit default schedule or add new schedules.

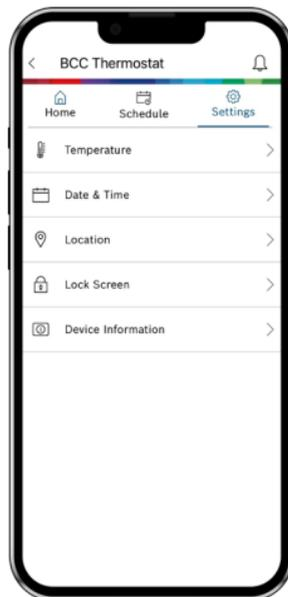

Settings

Use the Settings tab to adjust temperature settings, date & time, location, screen lock, and view device information.



**“Alexa, Set My
Thermostat to
72 degrees”**

Additional Features

Control Your BCC110 with Amazon Alexa

Bosch offers one Smart Home Skill for integrating your BCC110 with Alexa's voice controls. Using the Bosch EasyAir Skill from the Skills section of the Amazon Alexa App.



You Can Control the BCC110 by Saying:

- ▶ Alexa, turn (Device Name) on.
- ▶ Alexa, turn (Device Name) off.
- ▶ Alexa, Increase (Device Name) by __ degrees.
- ▶ Alexa, Decrease (Device Name) by __ degrees.
- ▶ Alexa, Set (Device Name) to __ degrees.
- ▶ Alexa, what is the (Device Name) set to?
- ▶ Alexa, what is the temperature of the (Device Name)?

Device Name

The Device Name is the name assigned to your device in the EasyAir app. You can check the device name by opening the EasyAir app and reading the name displayed on the main menu of selectable devices.

You must have a registered EasyAir account to set up and use your thermostat with Amazon Alexa.

Connecting Your BCC110 to Amazon Alexa

1. Download the Bosch EasyAir, create a SingleKey ID account, and add your BCC110 thermostat to the App.
2. Download the Amazon Alexa app and set up your Alexa-enabled device.
3. In the Amazon Alexa app, click on the Menu button in the top left corner.
4. Click on the Skills section and search for “Bosch EasyAir” in the search bar at the top of the page.
5. After you find and click on the Bosch EasyAir Skill, click on the blue Enable button.
6. The setup process redirects you to the SingleKey ID sign in page where you will need to enter your SingleKey ID username and password.
7. After you have received confirmation that your two accounts have been successfully linked, click Done in the top left hand corner.
8. Next click Discover Devices in the Amazon Alexa app or say “Alexa, discover new devices.” Device Discovery could take up to 45 seconds.
9. When device discovery is complete, you should see a list of connected devices in the Smart Home menu of your Amazon Alexa app.

The setup process is now complete and you can start to control your BCC110 with your Alexa-enabled device. Try out some of the commands and enjoy!

For further support, contact our customer service team at: 1-800-283-3787.

Additional Features

Control Your BCC110 with Google Assistant

Once installed and connected to the app, Bosch offers one Smart Home link for integrating your BCC110 with Google Assistant's voice controls. After setting up your thermostat as a new device in the Google Home app:



You Can Control the BCC110 by Saying:

- ▶ Hey Google, turn (Device Name) on.
- ▶ Hey Google, turn (Device Name) off.
- ▶ Hey Google, Increase (Device Name) by __ degrees.
- ▶ Hey Google, Decrease (Device Name) by __ degrees.
- ▶ Hey Google, Set (Device Name) to __ degrees.
- ▶ Hey Google, what is the (Device Name) set to?

Device Name

The Device Name is the name assigned to your device in the EasyAir app. You can check the device name by opening the EasyAir app and reading the name displayed on the main menu of selectable devices.

You must have a registered EasyAir account to set up and use your thermostat with Google Assistant.

Connecting Your BCC110 to Google Assistant

1. Download the Bosch EasyAir app, create a SingleKey ID account, and add your BCC110 thermostat to the App. You must have a registered BCC account to set up and use your thermostat with Google Assistant.
2. Download the Google Home app and set up your Google-enabled device.
3. In the Google Home app, click on the add button in the middle of the screen.
4. Click on Setup up device and select the link option under Works with Google. This is the last option on the page.
5. Search for Bosch EasyAir and click add new Bosch EasyAir.
6. The setup process redirects you to the SingleKey ID sign in page where you will need to enter your SingleKey ID account username and password.
7. Next choose the device(s) you want to link to your Google Home from the available list and click Next.
8. Choose a home for your new thermostat and click Next.
9. Choose a location for your thermostat and click Next

Note: If you have multiple devices, you can continue setting them up one by one until all your devices are setup. You can click the X on the top left hand corner to return to the home screen of the Google Home app at any time.

The set up process should now be complete and you can start to control your BCC110 thermostat with your Google-enabled device. Try out some of the commands and enjoy!

For further support, contact our customer service team at: 1-800-283-3787.

Warranty

MODELS COVERED

This limited warranty is provided by Bosch Thermotechnology Corp. (“Bosch”) and covers the Bosch Connected Control (BCC110) Wi-Fi Thermostat (hereinafter referred to as “Product”). This warranty is provided to the original purchaser of the Product as long as the Product remains installed at its original place of installation.

WARRANTY COVERAGE Limited Warranty

Bosch warrants that the Product will remain free from defects in material and workmanship for five (5) years from the date of original installation or from the date of manufacture if proof of installation is not available, provided it is properly installed and the other conditions of this warranty are met. If Bosch determines that the Product has a defect in workmanship or materials, Bosch, at its option, will repair or replace the defective part.

ITEMS NOT COVERED

This limited warranty does not cover the following circumstances:

1. Components or parts not provided by Bosch.
2. Components or parts, on which the tags or nameplates have been removed, altered or defaced.
3. Scratches in or discoloration of finishes.
4. The workmanship of any installer. Bosch disclaims and does not assume any liability of any nature for unsatisfactory performance caused by improper installation, repair or maintenance.
5. Any labor or material costs for removal, reinstallation, repair and replacement of the defective component or part unless otherwise provided above.
6. Electricity or fuel costs, or any increases or unrealized savings in same, for any reason whatsoever.
7. Damage caused by operation of the Product in a corrosive atmosphere, electrical failures, flooding or acts of God.
8. Damage caused by any attachment or modification to the Product, including any energy saving device.
9. Damage caused by Product not being installed in accordance with all applicable state and local plumbing and/or building codes and regulations.
10. Shipping charges, delivery expenses or administrative fees incurred by the purchaser in repairing or replacing the Product.

Warranty

LIMITED WARRANTY

OTHER THAN THE OBLIGATIONS OF BOSCH EXPRESSLY SET FORTH HEREIN, BOSCH DISCLAIMS ALL WARRANTIES, EXPRESS OR IMPLIED, INCLUDING BUT NOT LIMITED TO ANY IMPLIED WARRANTIES OF MERCHANTABILITY OR FITNESS FOR A PARTICULAR PURPOSE. BOSCH'S SOLE OBLIGATION WITH RESPECT TO THE PRODUCT AND PURCHASER'S EXCLUSIVE REMEDIES ARE SET FORTH IN THE FOREGOING LIMITED WARRANTY. BOSCH SHALL NOT BE LIABLE FOR ANY INDIRECT, PUNITIVE, INCIDENTAL, SPECIAL, CONSEQUENTIAL OR SIMILAR DAMAGES INCLUDING, WITHOUT LIMITATION, INJURY OR DAMAGE TO PERSONS OR PROPERTY OR DAMAGES FOR LOSS OF USE, LOST PROFITS, INCONVENIENCE OR LOSS OF TIME. NOTE THAT ANY REPAIRED OR REPLACED PRODUCT WILL BE WARRANTED FOR ONLY THE UNEXPIRED TERM OF THE ORIGINAL WARRANTY.

Some states do not allow the exclusion of limitation of damages, or limitations on how long an implied warranty lasts, so the above limitations and exclusions may not apply to you.

WARRANTY CLAIMS PROCESS

If you have a warranty claim you should notify the heating contractor who installed your Product and ask that the contractor notify the distributor from whom the contractor purchased the Product. If this action is not possible or you don't receive a response, contact Bosch Thermotechnology Corp. (Bosch), 50 Wentworth Avenue, Londonderry, NH 03053. To process your claim, you will need a copy of your original invoice or other proof of purchase and documentation showing the original installation date and location. The alleged defective Product must be returned to Bosch in accordance with Bosch procedure then in force for handling goods returned for the purpose of inspection to determine cause of failure (contact Bosch if you have questions regarding the return process). If Bosch determines that the returned product is defective and that this warranty applies, Bosch will furnish the repaired or replacement Product.

THIS WARRANTY APPLIES TO PRODUCTS PURCHASED, DELIVERED AND USED WITHIN THE FIFTY STATES OF THE UNITED STATES, THE DISTRICT OF COLUMBIA AND PUERTO RICO.



Bosch Home Comfort Group

Watertown, MA | Londonderry, NH | Ft. Lauderdale, FL

General Inquiries: 1-866-642-3198

Copyright © 2023 Bosch Home Comfort Group
All rights reserved. Subject to change without notice.

76H993391A 1/24

www.bosch-homecomfort.us